

Linka Plan

English Instructions #101-BM p-1

Brickwork Moulds RVDV

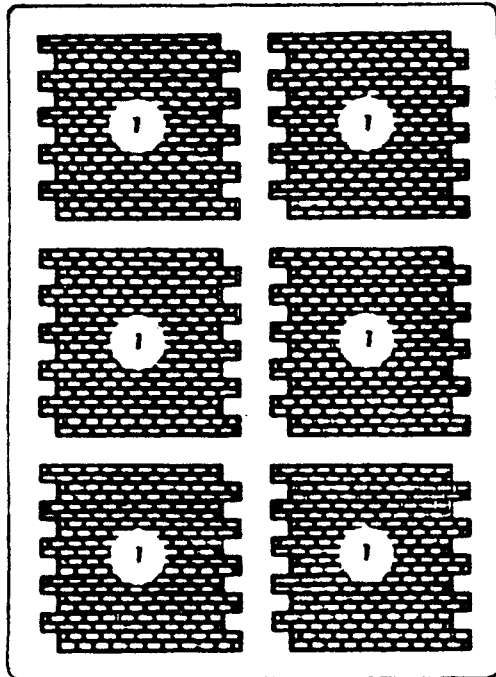

A1=B-1

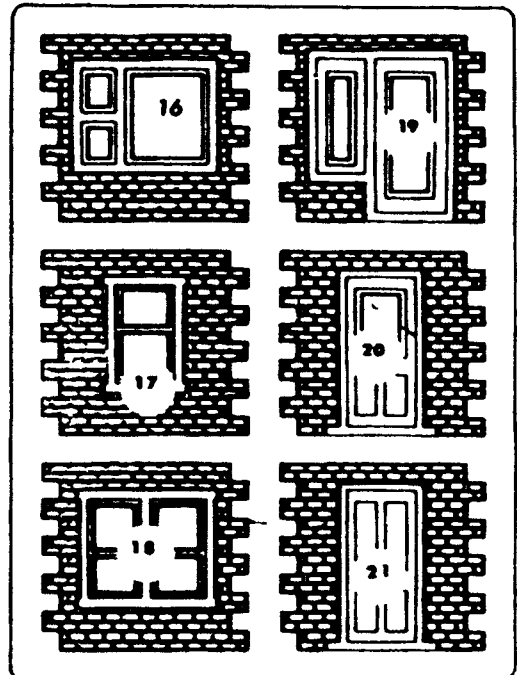

A2=B-2

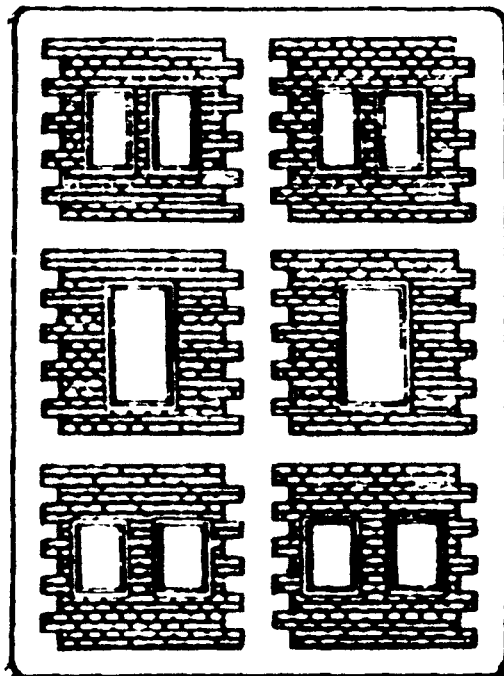

00=B-3

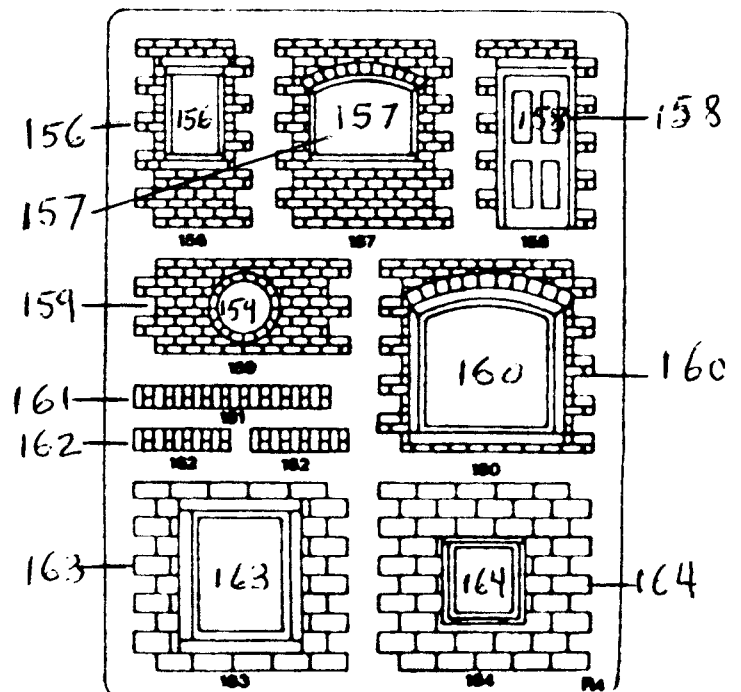

R4=B-4

Linka Plan

Brickwork Moulds

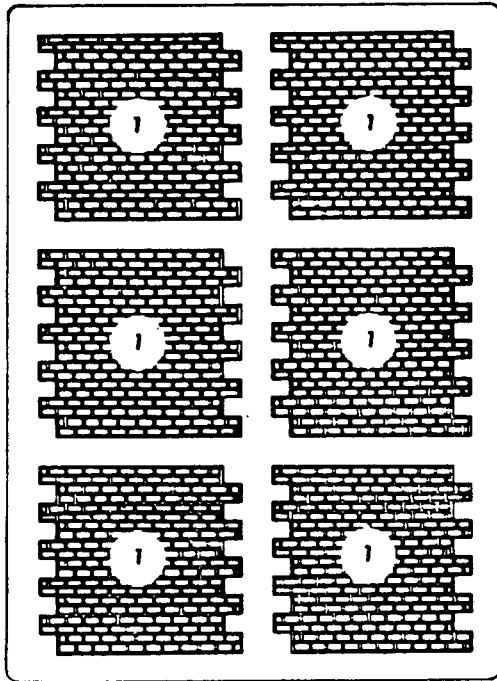

B-1

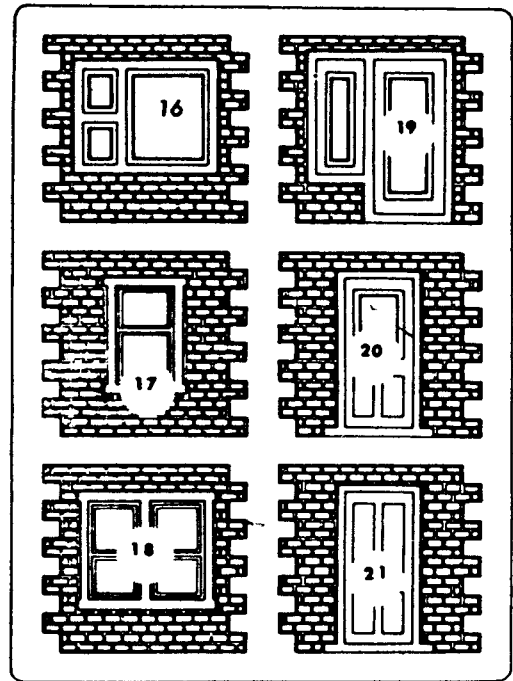

B-2

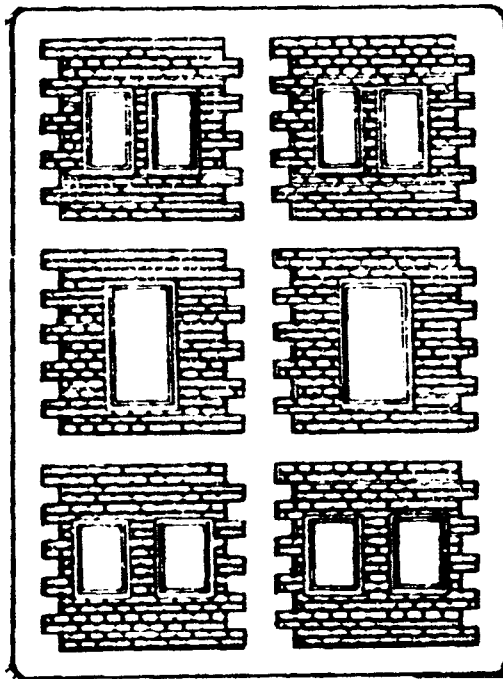

B-3

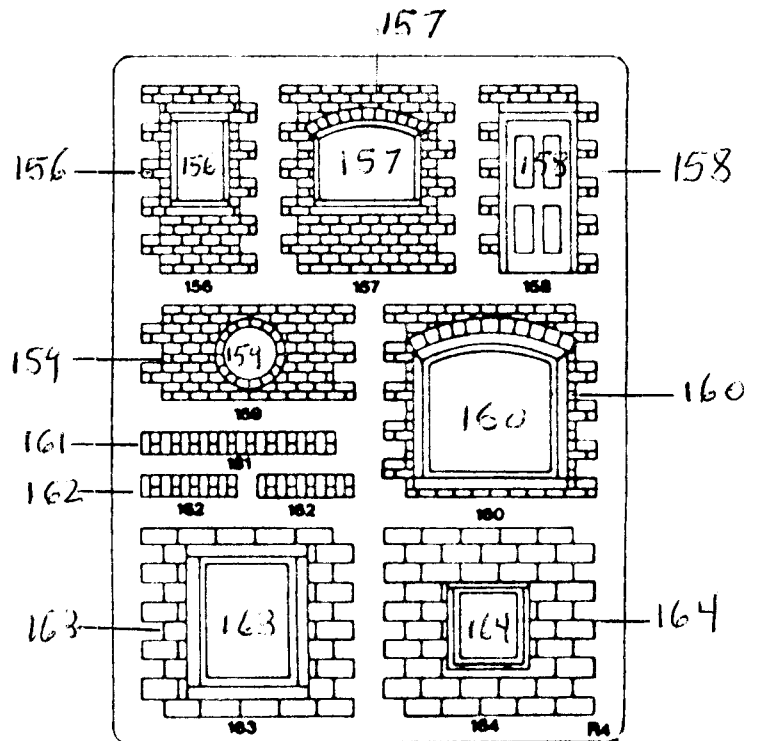

B-4

Linka Plan

Brickwork Moulds

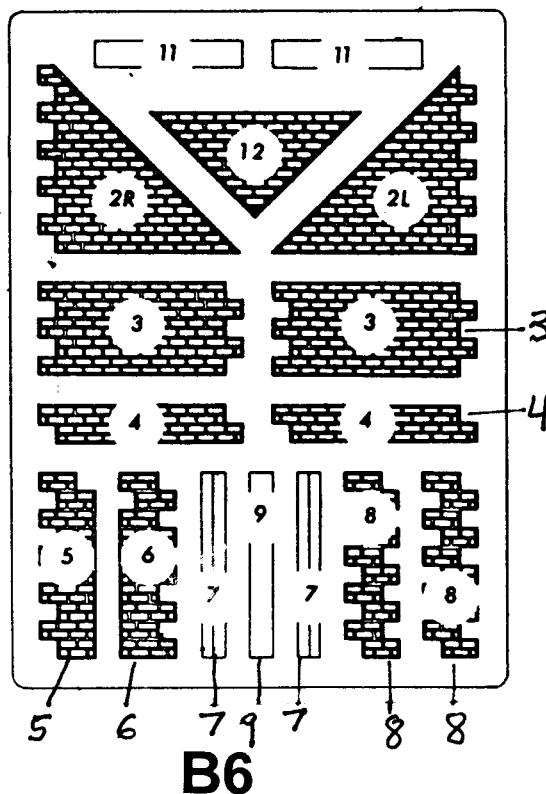
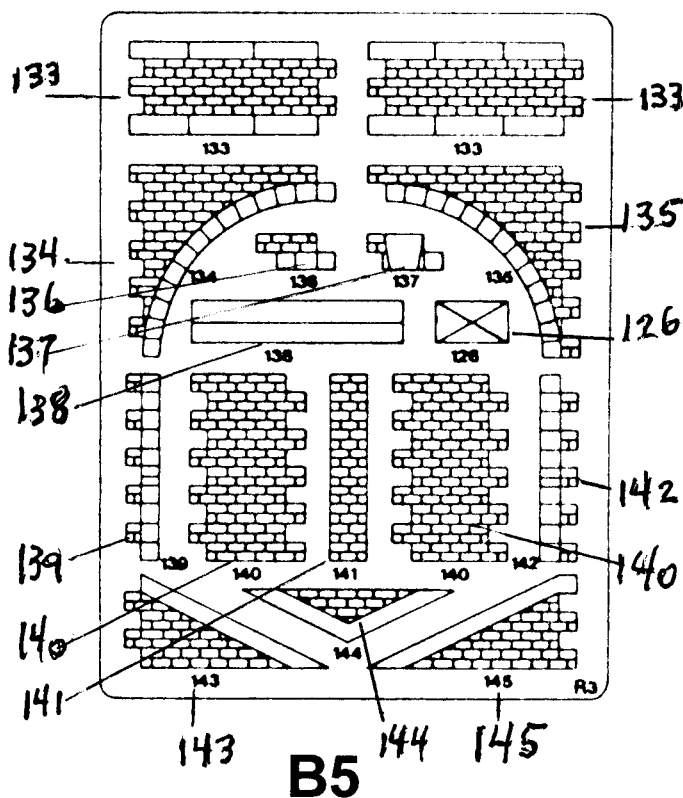

Conversion table

B1 = A1	A1 = B1
B2 = A4	A2 = B6
B3 = ---	--- = B3
B4 = R4	A4 = B2
B5 = R3	R3 = B5
B6 = A2	R4 = B4

Linka Plan

English Instructions #101 BM p-3

Brickwork Moulds

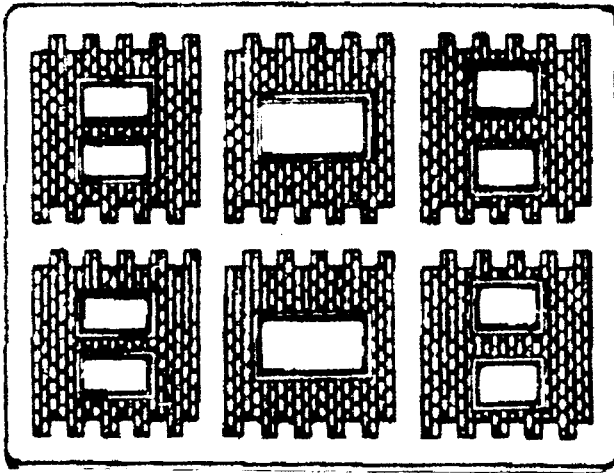

00 = Mould B-3

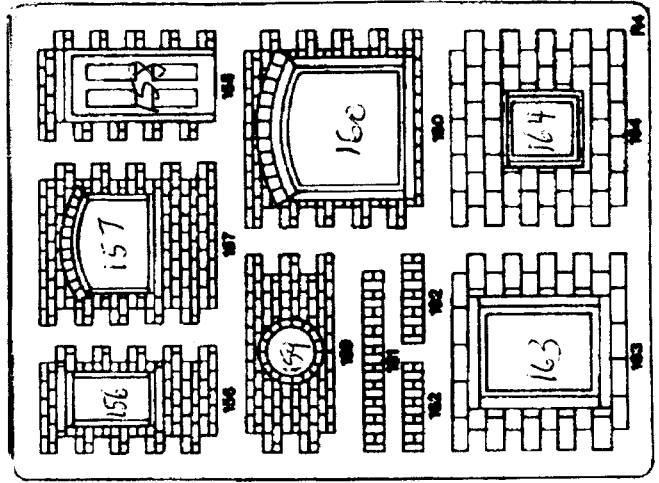

R4 = B-4

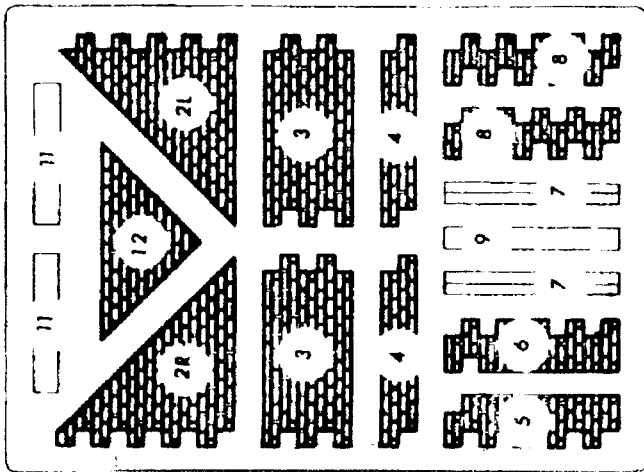

A2 = B6

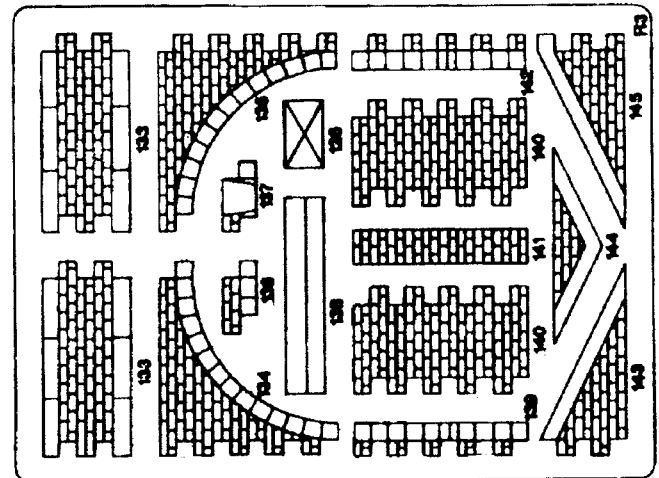

R3 = B-5

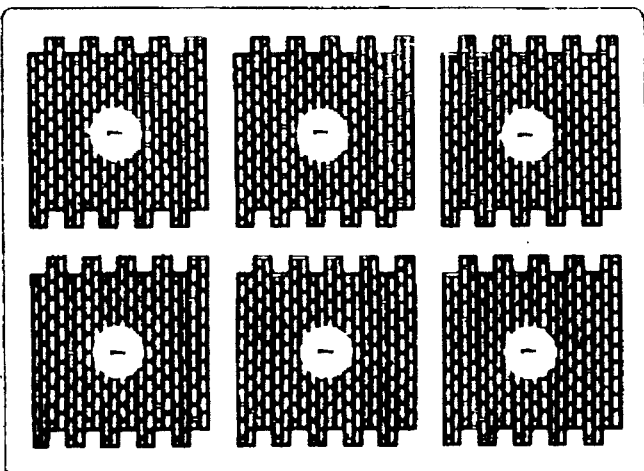

A1 = Mould B-1

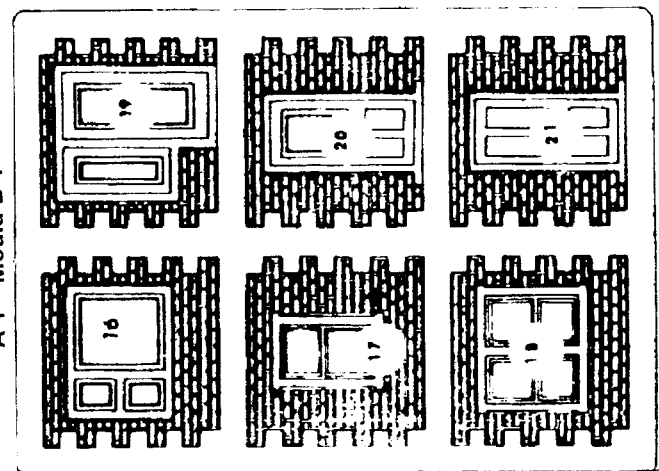

A4 = Mould B-2

Linka Plan

English Instructions #101 BM p-4

Brickwork Moulds

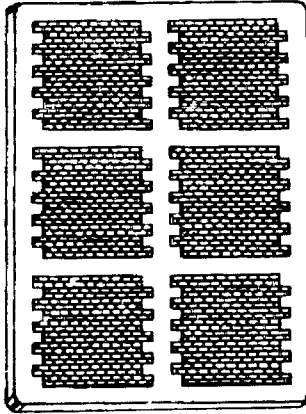

B1 Standard brickwork sections.

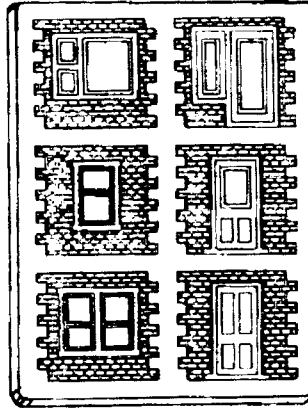

B2 Panel and glass doors, modern, single & double windows.

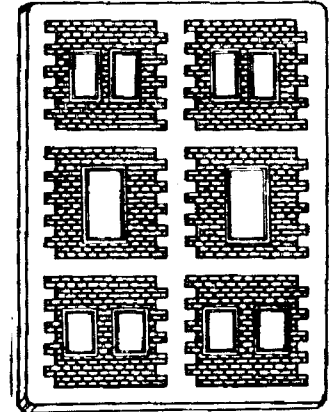

B3 Standard sections with various window spaces.

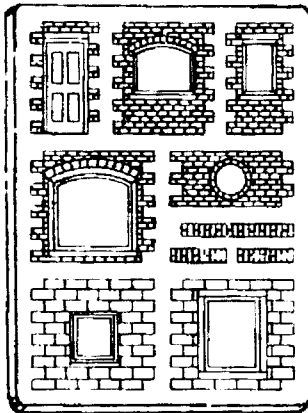

B4 Skylights, circular and arched windows, door & buttresses.

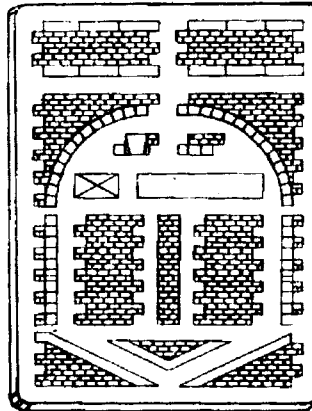

B5 Arches, wall sections, half panels, buttress, gables, copings.

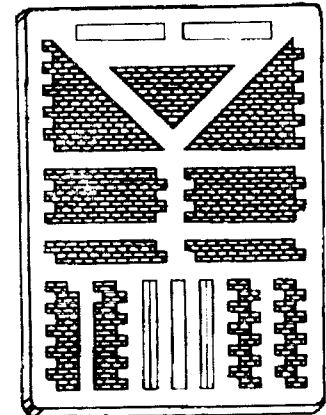

B6 Gables, extensions, half sections, coping & coving.

Linka Plan

English Instructions #102 SM p-1

Stonework Moulds

C1 = S1

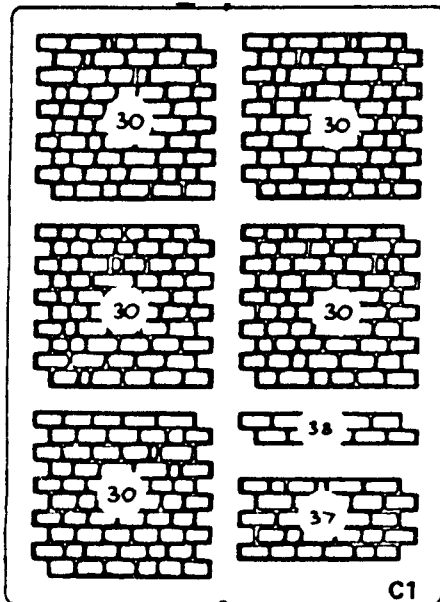

S-1

C2 = S4

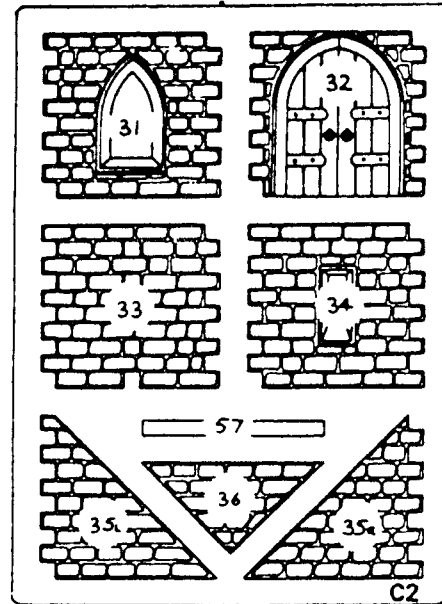

S-4

C4 = S5

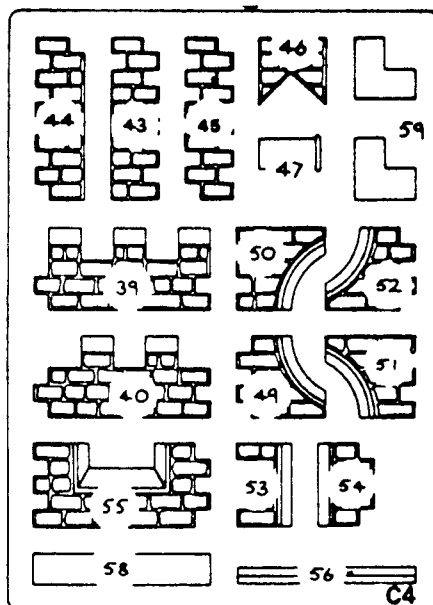

S-5

C5 = S6

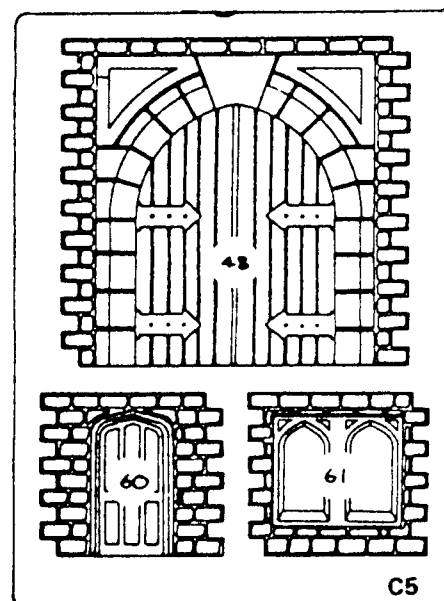

S-6

Linka Plan

English instructions #102 SM p-2

Stonework Moulds

R-2 = S-2

R-1 = S-3

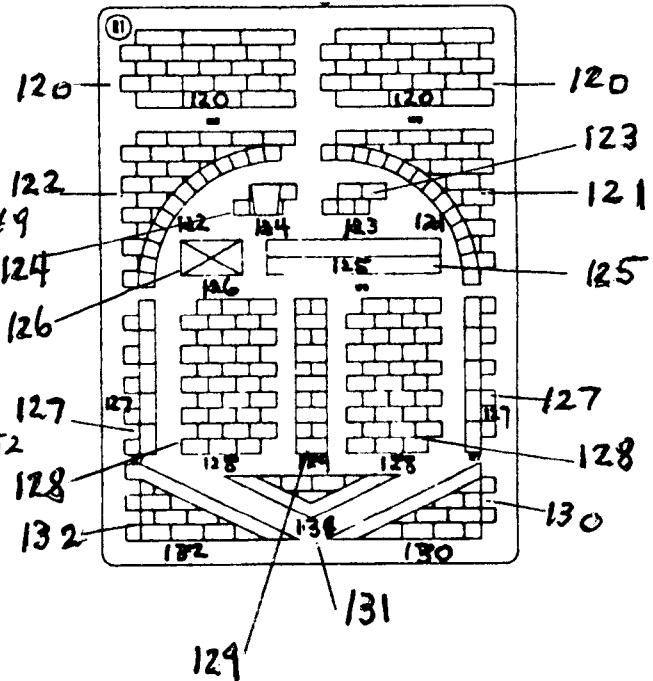
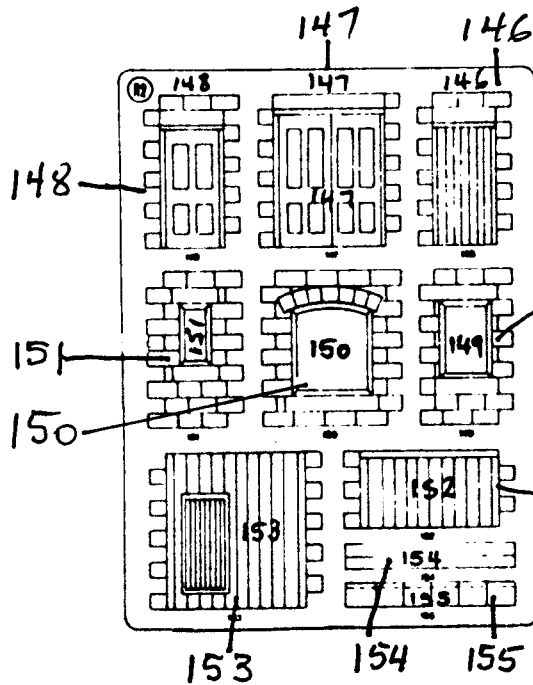

Conversion Table

Old Numbers

New Numbers

C-1 = S-1

C-1 = S-1

C-2 = S-4

C-2 = S-4

C-4 = S-5

C-4 = S-5

C-5 = S-6

C-5 = S-6

R-1 = S-3

R-1 = S-3

R-2 = S-2

R-2 = S-2

Linka Plan

English Instructions #103-TM p-1

Timber Moulds RVDV

T-1

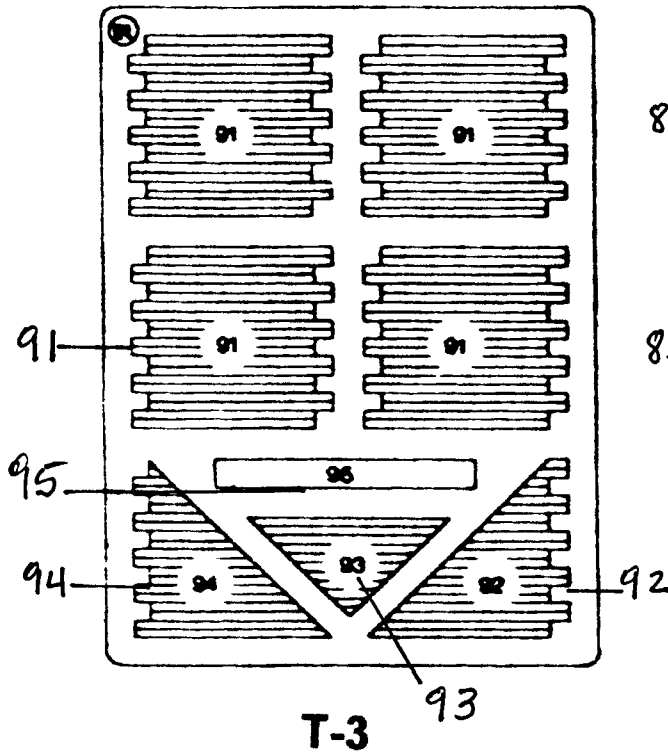

T-2

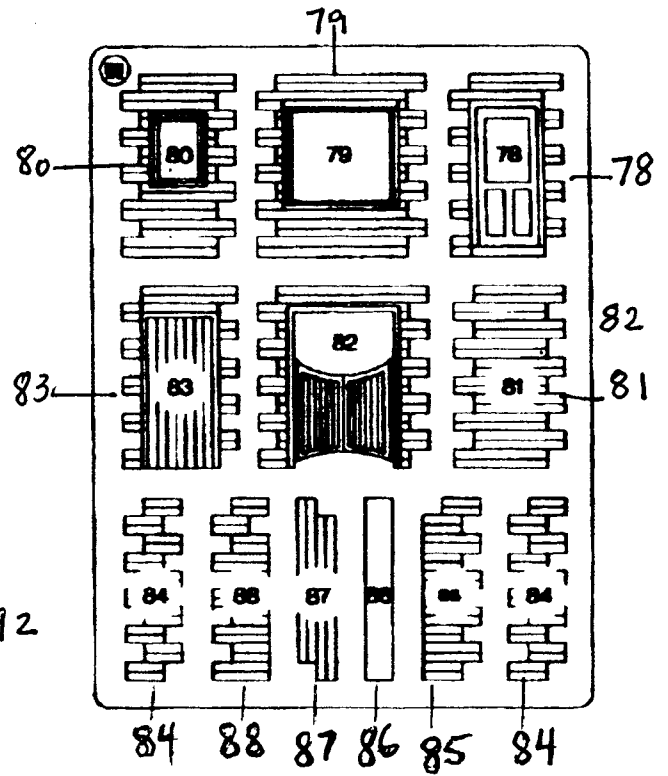

T-3

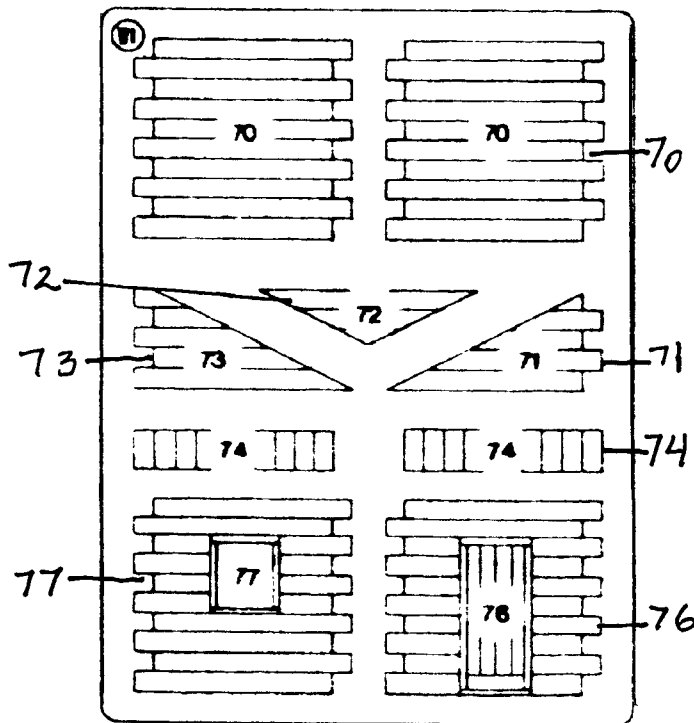

Timber moulds Conversion table

T-1	=	W-4
T-2	=	W-2
T-3	=	W-1

Linka Plan

Roofing Moulds

R-1

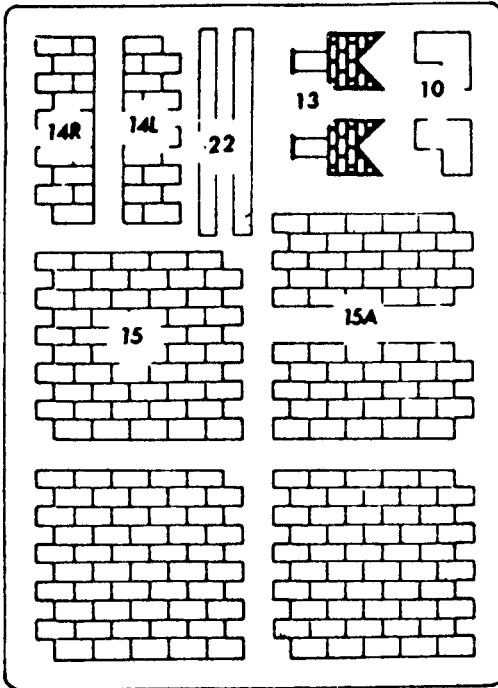

R-2

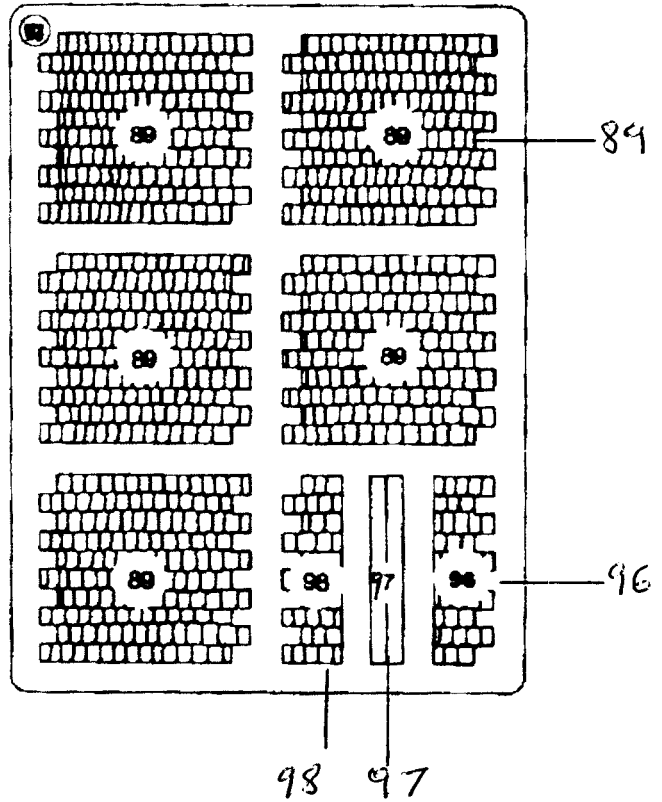

R-3

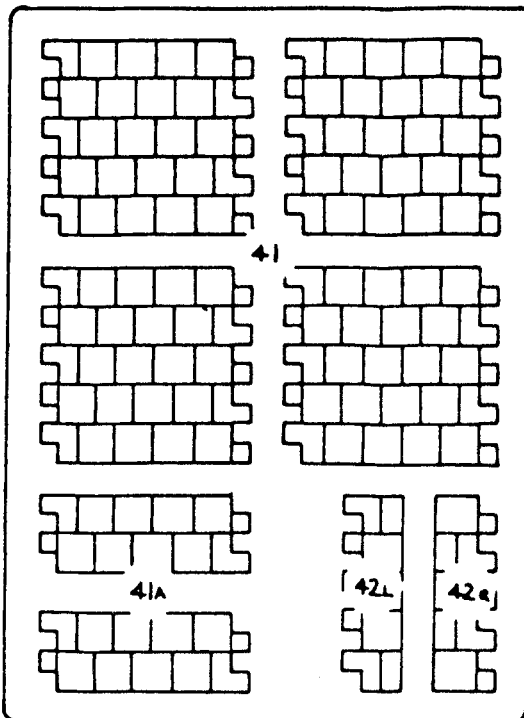

Conversion table

R-1 = A-3

R-2 = W-3

R-3 = C-3